

5000 series

Toggle switches

Distinctive features

THE WIDEST RANGE IN MINIATURE SWITCHES



- 17 actuators including toggles, paddle levers and locking levers in different lengths.

- 5 contact materials from dry circuit to 6A 125VAC and high inrush up to 120A 2 ms.

- 8 functions including maintained and momentary versions.

- 1 to 4 pole configurations.



- 12 terminal types including 9 for PC board mounting. Other types include quick-connect and wire-wrap.

- 6 bushing styles from 6 (.236) plain to 11,9 (15/32) threaded.

- 3 types of finish including military black.



- 4 approvals (UL - CSA - VDE - CECC) and 3 listings.

- 4 types of sealing for terminal or front panel requirements.

- Numerous accessories available for actuator and bushing options.

5000 series

Toggle switches

Specifications

ELECTRICAL SPECIFICATIONS

- Current/voltage rating with resistive load :

Contact	Maximum	Minimum	Level*
Silver (A)	3A 250VAC - 6A 125VAC - 4A 30VDC	50mA 10VDC	III and IV
Silver, gold plated (AD)	3A 250VAC - 6A 125 VAC - 4A 30VDC Gold plating withstands up to 100mA 30VDC	10mA 50mV 10 μ A 5V	I to IV
Brass, gold plated (CD)	0,4 VA at 20VAC or DC	10mA 50mV 10 μ A 5V	I and II

- For inductive, lamp or capacitive load, consult factory. * For details, see Technical Information, end of catalogue.
- Initial contact resistance : 10 m Ω max.
- Insulation resistance : 1.000 M Ω min. at 500VDC
- Dielectric strength :
 - 1.000 Vrms 50 Hz min. between terminals
 - 1.500 Vrms 50 Hz min. between poles
 - 1.500 Vrms 50 Hz min. between terminals and frame
- Contact bounce : 2 ms max.
- Electrical life at full load :
 - 50.000 cycles for single and double pole
 - 40.000 cycles for 3 pole
 - 30.000 cycles for 4 pole
- Low level or mechanical life : 100.000 cycles

MATERIALS

- Case : diallylphthalate (DAP) or high temperature plastic material (UL94-V0)
- Actuator : brass, nickel plated
- Paddles : UL94HB polyamide
- Lever caps : vinyl
- Bushing : brass, nickel plated
- Housing : stainless steel or steel tin plated
- Contacts
 - A** : silver
 - AD** : silver, gold plated
 - CD** : brass, gold plated
 - X814** : for peak currents, see "Special options".
- Terminal seal : epoxy

GENERAL SPECIFICATIONS

- Torque : 1,25 Nm (.922 Ft.lb) max. applied to nut
- Panel thickness : 2,5 mm (.098) with 2 nuts - 4 mm (.157) with 1 nut
- Operating temperature : -40°C to +85°C

AGENCY APPROVALS/PREFERENTIAL LIST



EN 61058-1



CECC 96201-007

For VDE, refer to 55000 series.

NATO

Availability : consult factory for details of approved models.

Marking : to order switches marked UL, CSA or CECC, complete appropriate box of ordering format. The preferential list does not appear on the switches.

5000 series

Toggle switches

Overview

MODEL
STRUCTURE

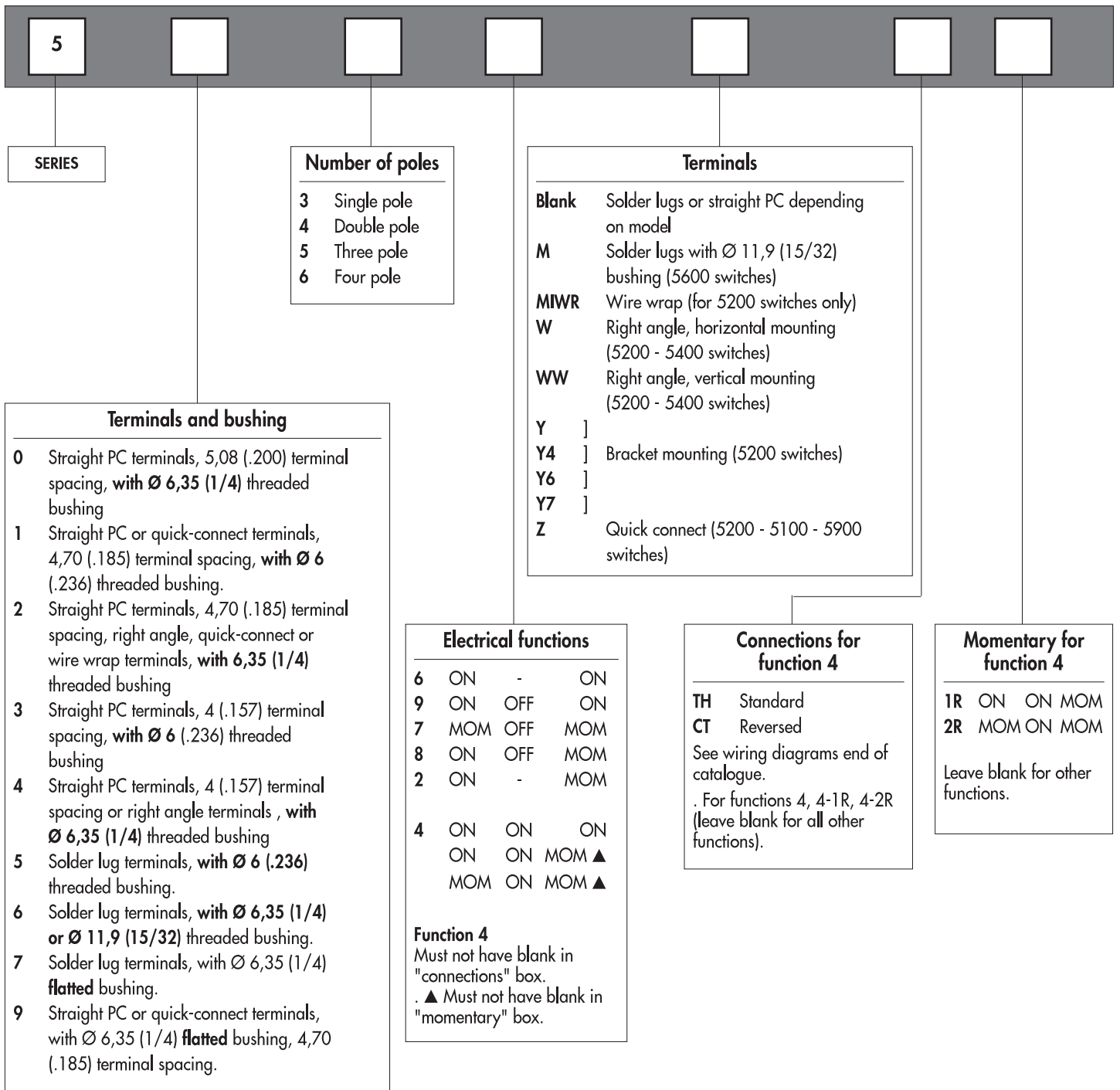

ABOUT THIS SERIES

- On the following pages, you will find successively :
- model structure of switches with threaded bushing
 - model structure of switches with plain bushing
 - options in the same order as in above chart

Dimensions : first dimensions are in mm while inches are shown as bracketted numbers.



NOTICE : please note that not all combinations of above numbers are available. Refer to the following pages for further information.



5000 series

Toggle switches

Overview

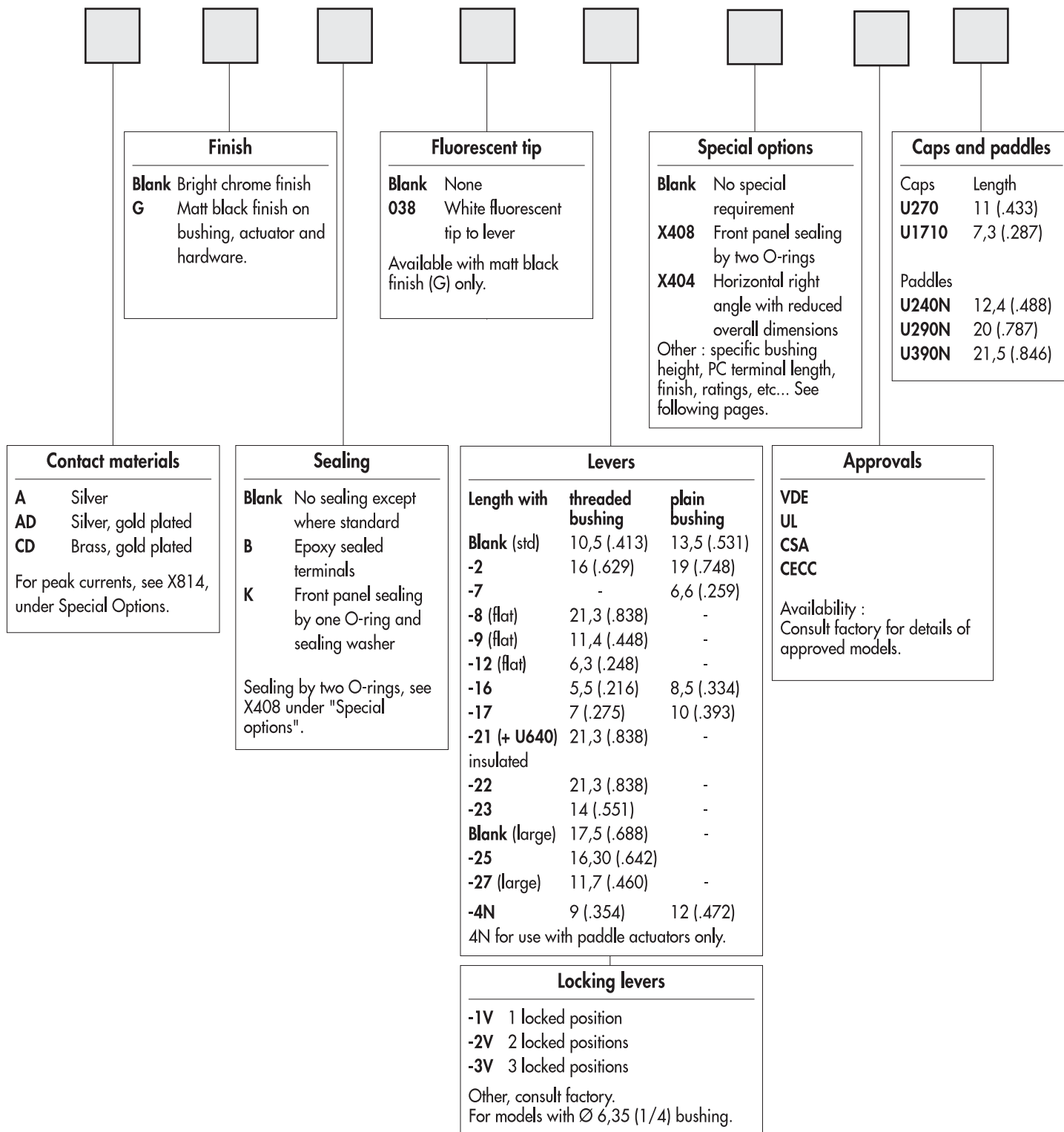

Sealing boots are available. They are presented in section H.



Mounting accessories : standard hardware supplied with all models with Ø 6,35 (1/4) or Ø 6 (.236) threaded bushing : 2 hex nuts 8 mm (.314) across flats, 1 locking ring and 1 lockwasher. Standard and special hardware available are presented in section I.



Packaging unit : 25 pieces or 50 pieces depending on models.

5000 series

Toggle switches - solder lug terminals

Threaded bushing $\varnothing 6,35 (1/4) : 5600$



→ Keyway

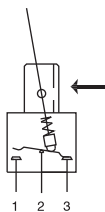

• 1, 2, 3 and 4 pole configurations

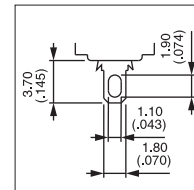

MODEL STRUCTURE

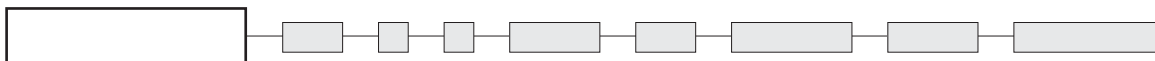

Shown with standard lever

Single pole



5636
5639
5637
5638
5632

III	II	I
2-3		1-2
ON	-	ON
ON	OFF	ON
MOM	OFF	MOM
ON	OFF	MOM
ON	-	MOM

→ Keyway

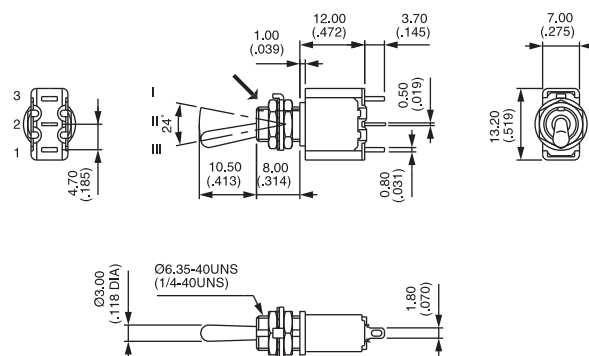

Double pole



5646
5649
5647
5648
5642
5644*
5644 1R*
5644 2R*

III	II	I
2-3		1-2
5-6		4-5
ON	-	ON
ON	OFF	ON
MOM	OFF	MOM
ON	OFF	MOM
ON	-	MOM
ON	ON	ON
ON	ON	MOM
MOM	ON	MOM

→ Keyway

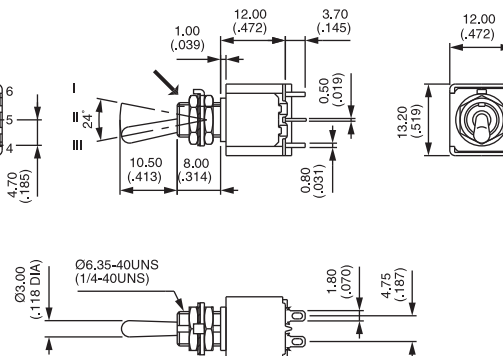

* Function 4 : SP in DP case - specify CT or TH connections, see end of catalogue.

Three pole



5656
5659
5657
5658
5652

III	II	I
2-3		1-2
5-6		4-5
8-9		7-8
ON	-	ON
ON	OFF	ON
MOM	OFF	MOM
ON	OFF	MOM
ON	-	MOM

→ Keyway

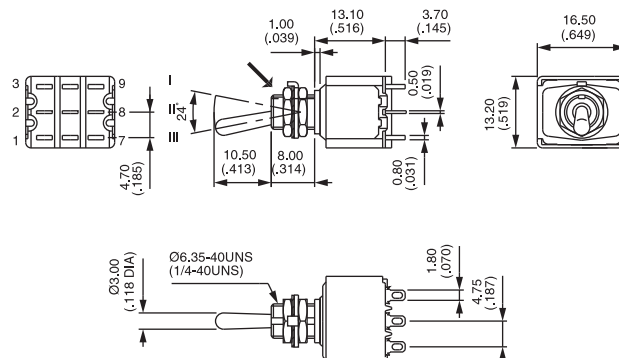



5000 series

Toggle switches - solder lug terminals

Threaded bushing $\varnothing 6,35$ (1/4) : 5600

Four pole



5666
5669
5667
5668
5662
5664*
5664 1R*
5664 2R*

III	II	I
2-3		1-2
5-6		4-5
8-9		7-8
11-12		10-11
	ON -	ON
	ON OFF	ON
	MOM OFF	MOM
	ON OFF	MOM
	ON -	MOM
	ON ON	ON
	ON ON	MOM
	MOM ON	MOM

→ Keyway

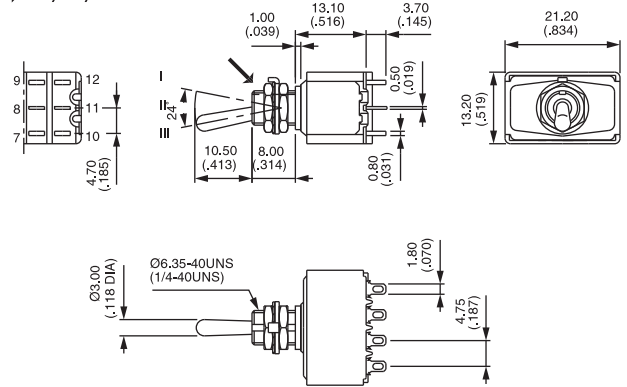

*Function 4 : DP in 4P case - specify CT or TH connections, see end of catalogue.

PANEL CUT-OUT

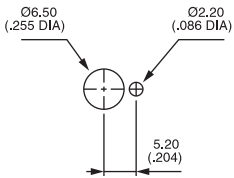

Standard

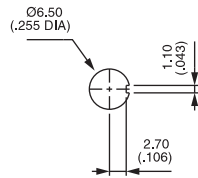

With K
sealing option

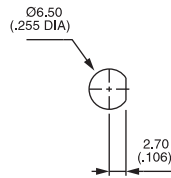

With X408
sealing option

5000 series

Toggle switches - solder lug terminals

MODEL
STRUCTURE

A

Diagram as per 5600 model

5700 models

- Flatted bushing $\varnothing 6,35$ mm (1/4)
- 1, 2, 3 and 4 pole configurations

MODEL
STRUCTURE

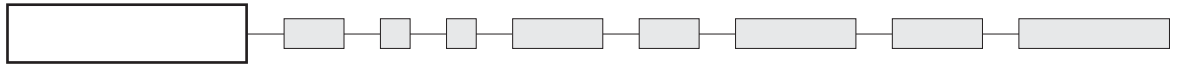

For model structure numbers, refer to 5600 models and replace 6 with 7.

PANEL CUT-OUT

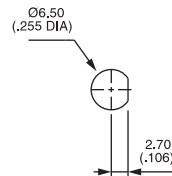

Standard or
with K sealing option

5500 models

- Threaded bushing $\varnothing 6$ mm x 0.75 SI (.236 x 0.75 IS)
- 1, 2, 3 and 4 pole configurations

MODEL
STRUCTURE

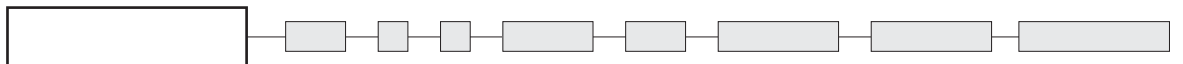
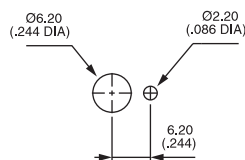

Diagram as per 5600 model

For model structure numbers, refer to 5600 models and replace 6 with 5.

PANEL CUT-OUT



Standard

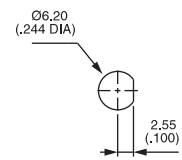

With X408 sealing option



5000 series

Toggle switches - solder lug terminals

Threaded bushing $\varnothing 11,9$ (15/32) : 5600M

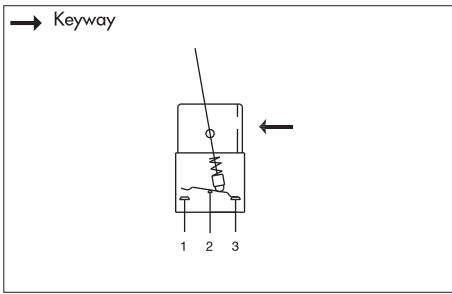

- 1, 2, 3 and 4 pole configurations
- Supplied with 2 hex nuts and 1 locking ring
- Panel thickness up to 6 mm (.236)

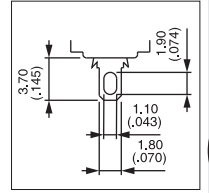

MODEL STRUCTURE

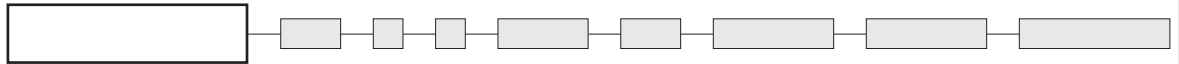

Shown with standard lever

Single pole



5636M
5639M
5637M
5638M
5632M

III	II	I
2-3		1-2
ON	-	ON
ON	OFF	ON
MOM	OFF	MOM
ON	OFF	MOM
ON	-	MOM

→ Keyway

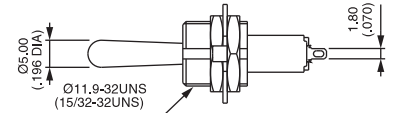
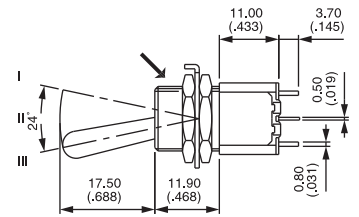
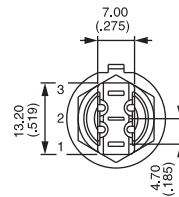

Double pole



5646M
5649M
5647M
5648M
5642M
5644M*
5644M 1R*
5644M 2R*

III	II	I
2-3		1-2
5-6		4-5
ON	-	ON
ON	OFF	ON
MOM	OFF	MOM
ON	OFF	MOM
ON	-	MOM
ON	ON	ON
ON	ON	MOM
MOM	ON	MOM

→ Keyway

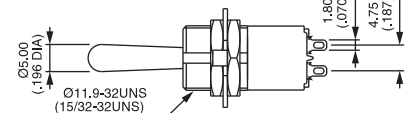
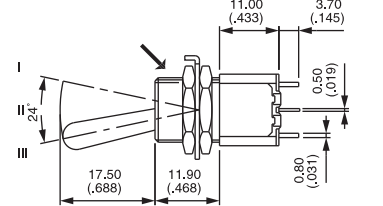
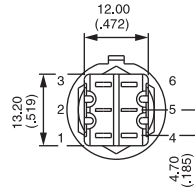

* Function 4 : SP in DP case - specify CT or TH connections, see end of catalogue.

Three pole



5656M
5659M
5657M
5658M
5652M

III	II	I
2-3		1-2
5-6		4-5
8-9		7-8
ON	-	ON
ON	OFF	ON
MOM	OFF	MOM
ON	OFF	MOM
ON	-	MOM

→ Keyway

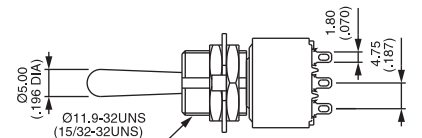
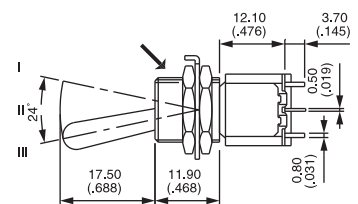
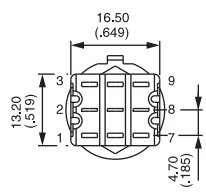

5000 series

Toggle switches - solder lug terminals

Threaded bushing \varnothing 11,9 (15/32) : 5600M

MODEL
STRUCTURE

Four pole



5666M
5669M
5667M
5668M
5662M
5664M*
5664M 1R*
5664M 2R*

III	II	I
2-3		1-2
5-6		4-5
8-9		7-8
11-12		10-11

ON	-	ON
ON	OFF	ON
MOM	OFF	MOM
ON	OFF	MOM
ON	-	MOM
ON	ON	ON
ON	ON	MOM
MOM	ON	MOM

→ Keyway

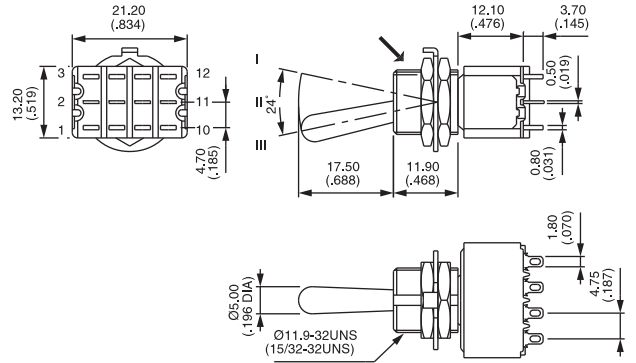

*Function 4 : DP in 4P case - specify CT or TH connections, see end of catalogue.

PANEL CUT-OUT

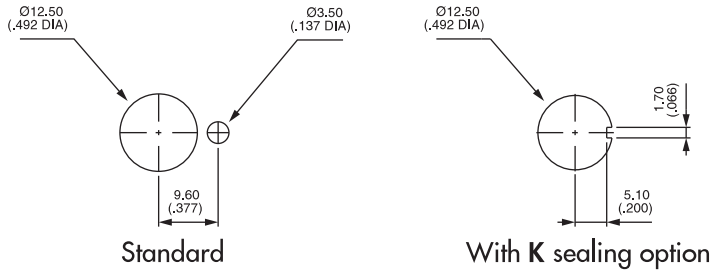

OTHER : M bushing can be combined with other types such as : 5200, Z, MIWR... Consult factory.



5000 series

Toggle switches - straight PC terminals

Threaded bushing $\varnothing 6,35$ (1/4) : 5200

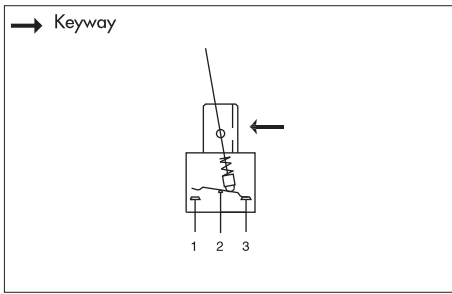

- Terminal spacing 4,7 mm (.185)
- 1, 2, 3 and 4 pole configurations
- Epoxy sealed terminals standard

For new projects, we recommend switches with support bracket (option Y) which holds the switch securely on the PCB.

Other terminal lengths presented under "Special options".

Also available with plain bushing, see "Special options" X371

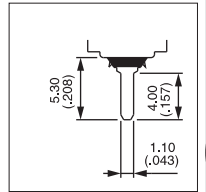

MODEL STRUCTURE

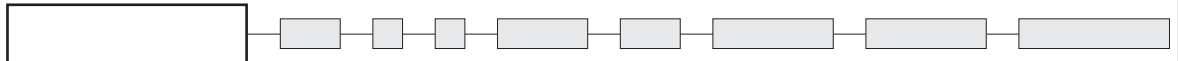

Shown with standard lever

Single pole



- 5236 B
- 5239 B
- 5237 B
- 5238 B
- 5232 B

III	II	I
2-3		1-2
ON	-	ON
ON	OFF	ON
MOM	OFF	MOM
ON	OFF	MOM
ON	-	MOM

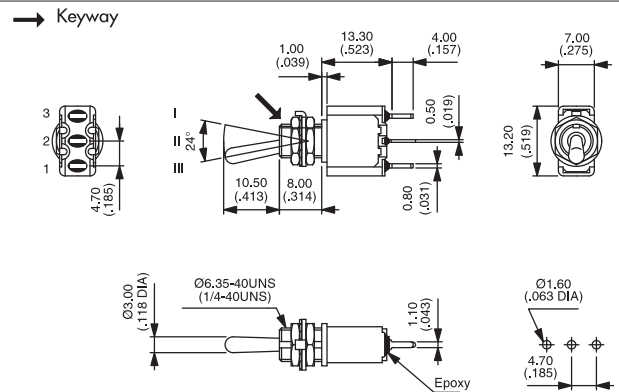

Double pole



- 5246 B
- 5249 B
- 5247 B
- 5248 B
- 5242 B
- 5244 B*
- 5244 1R B*
- 5244 2R B*

III	II	I
2-3		1-2
5-6		4-5
ON	-	ON
ON	OFF	ON
MOM	OFF	MOM
ON	OFF	MOM
ON	-	MOM
ON	ON	ON
ON	ON	MOM
MOM	ON	MOM

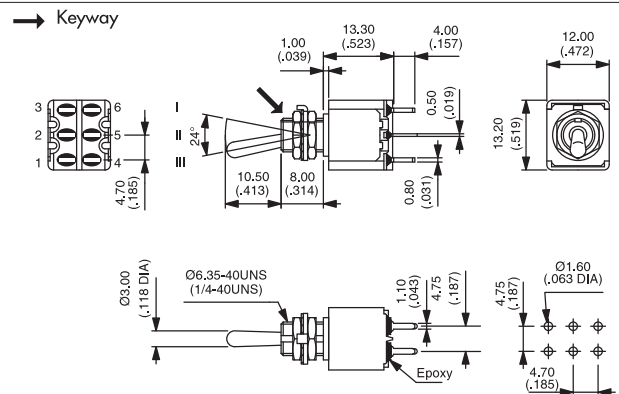

*Function 4 : SP in DP case - specify CT or TH connections, see end of catalogue.

Three pole



- 5256 B
- 5259 B
- 5257 B
- 5258 B
- 5252 B

III	II	I
2-3		1-2
5-6		4-5
8-9		7-8
ON	-	ON
ON	OFF	ON
MOM	OFF	MOM
ON	OFF	MOM
ON	-	MOM

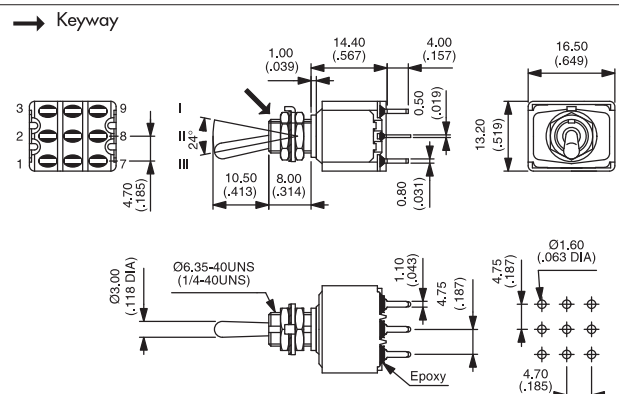

5000 series

Toggle switches - straight PC terminals

Threaded bushing $\varnothing 6,35 (1/4)$: 5200 - 5000



Four pole



5266 B
5269 B
5267 B
5268 B
5262 B
5264 B*
5264 1R B*
5264 2R B*

III	II	I
2-3		1-2
5-6		4-5
8-9		7-8
11-12		10-11
	ON -	ON
	ON OFF	ON
	MOM OFF	MOM
	ON OFF	MOM
	ON -	MOM
	ON ON	ON
	ON ON	MOM
	MOM ON	MOM

→ Keyway

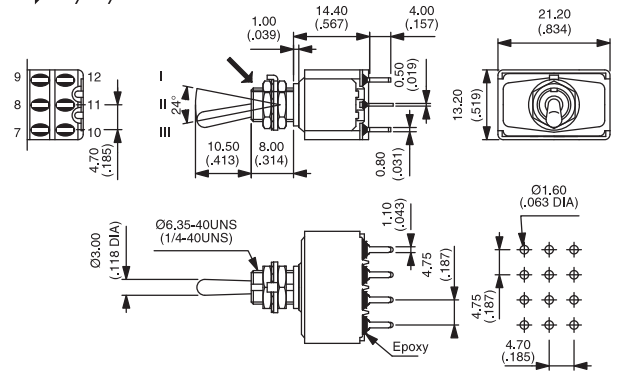

*Function 4 : DP in 4P case - specify CT of TH connections, see end of catalogue.

PANEL CUT-OUT

5200 - 5000 - 5400

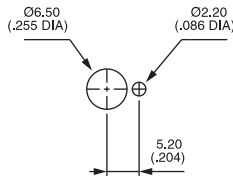

Standard

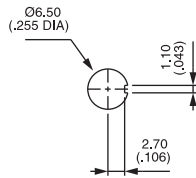

With K sealing option

5000 models

- Terminal spacing 5,08 mm (.200)
- Epoxy sealed terminals standard
- 1 and 2 pole configurations

Diagram as per 5200 model

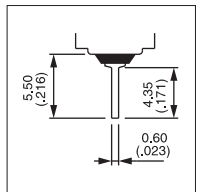

MODEL
STRUCTURE

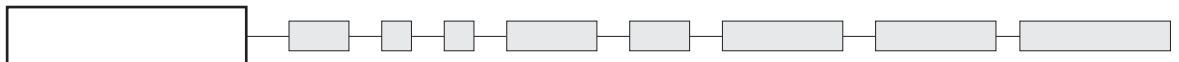

Shown with standard lever

Terminal spacing 5,08 (.200) - single and double pole

→ Keyway



Single pole	Double pole
5036	5046
5039	5049
5037	5047
5038	5048
5032	5042
	5044*
	5044 1R*
	5044 2R*

III	II	I
2-3		1-2
5-6		4-5
	ON -	ON
	ON OFF	ON
	MOM OFF	MOM
	ON OFF	MOM
	ON -	MOM
	ON ON	ON
	ON ON	MOM
	MOM ON	MOM

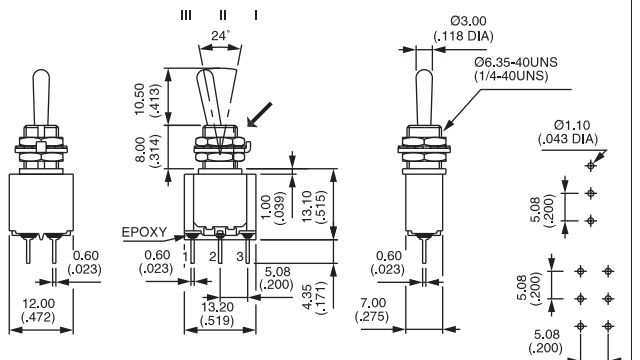

*Function 4 : SP in DP case - specify CT or TH connections, see end of catalogue.



5000 series

Toggle switches - straight PC terminals

A

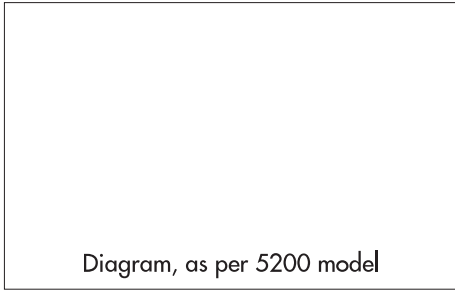

5400 models

- Threaded bushing $\varnothing 6,35$ mm (1/4)
- Terminal spacing 4 mm (.157)
- 1, 2, 3 and 4 pole configurations

MODEL STRUCTURE

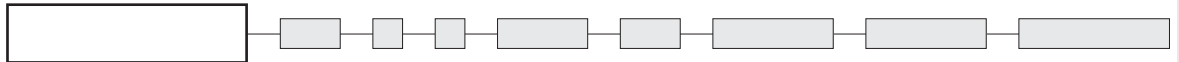

For model structure numbers, refer to 5200 models and replace 2 with 4.

Panel cut-out, see 5200.

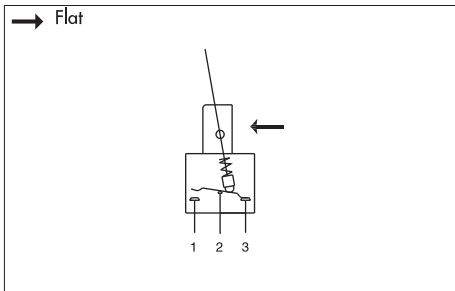

5900 models

- Flatted bushing $\varnothing 6,35$ mm (1/4)
- Terminal spacing 4,7 mm (.185)
- 1, 2, 3 and 4 pole configurations

MODEL STRUCTURE

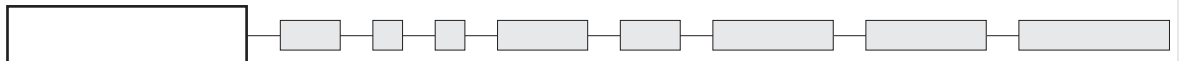

For model structure numbers, refer to 5200 models and replace 2 with 9.

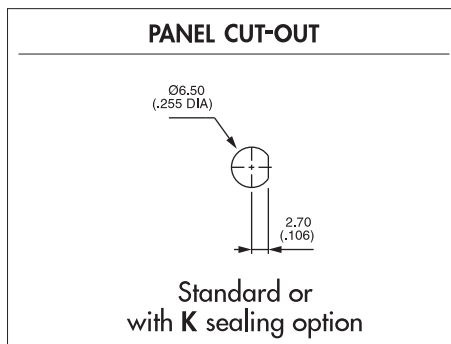

5000 series

Toggle switches - straight PC terminals

MODEL
STRUCTURE

A

Diagram, as per 5200 model

5100 models

- Threaded bushing $\varnothing 6 \text{ mm} \times 0.75 \text{ SI}$ (.236 x 0.75 IS)
- Terminal spacing 4,7 mm (.185)
- 1, 2, 3 and 4 pole configurations

MODEL
STRUCTURE

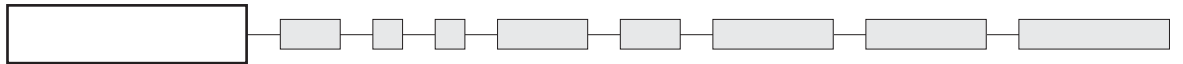

For model structure numbers, refer to 5200 models and replace 2 with 1.

Panel cut-out, see below.

5300 models

- Threaded bushing $\varnothing 6 \text{ mm} \times 0.75 \text{ SI}$ (.236 x 0.75 IS)
- Terminal spacing 4 mm (.157)
- 1, 2, 3 and 4 pole configurations

MODEL
STRUCTURE

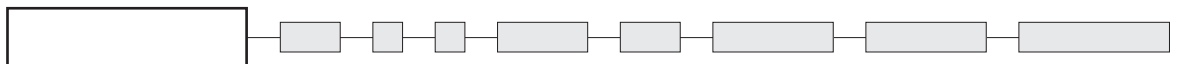

For model structure numbers, refer to 5200 models and replace 2 with 3.

Diagram, as per 5200 model

PANEL CUT-OUT

5100 - 5300

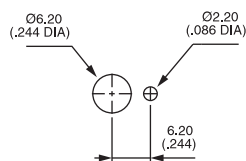

Standard

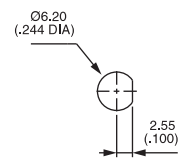

With X408 sealing option



5000 series

Toggle switches - quick-connect terminals

Threaded bushing $\varnothing 6,35$ (1/4) : 5200Z

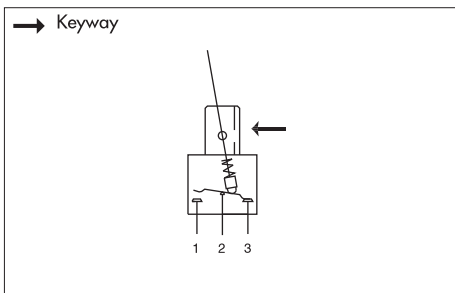

- Terminal spacing 4,7 mm (.185)
- Epoxy sealed terminals standard
- 1 and 2 pole configurations

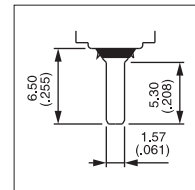

MODEL STRUCTURE

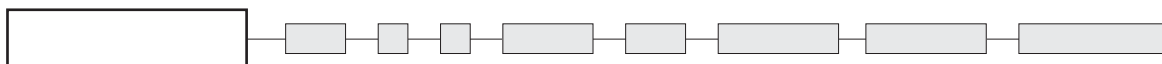

Shown with standard lever

Single pole



5236Z
5239Z
5237Z
5238Z
5232Z

III	II	I
2-3		1-2
ON	-	ON
ON	OFF	ON
MOM	OFF	MOM
ON	OFF	MOM
ON	-	MOM

→ Keyway

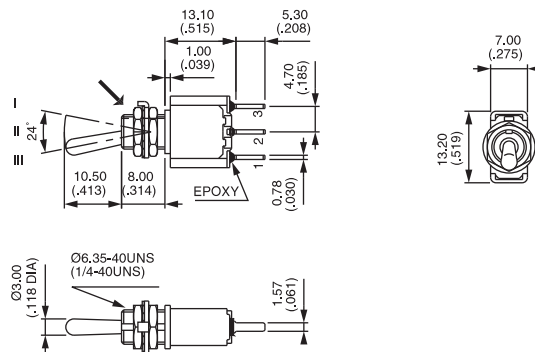

Double pole



5246Z
5249Z
5247Z
5248Z
5242Z
5244Z*
5244Z 1R*
5244Z 2R*

III	II	I
2-3		1-2
5-6		4-5
ON	-	ON
ON	OFF	ON
MOM	OFF	MOM
ON	OFF	MOM
ON	-	MOM
ON	ON	ON
ON	ON	MOM
MOM	ON	MOM

→ Keyway

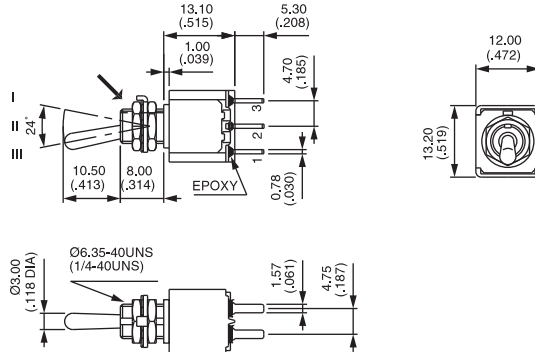

*Function 4 : SP in DP case - specify CT or TH connections, see end of catalogue.

PANEL CUT-OUT

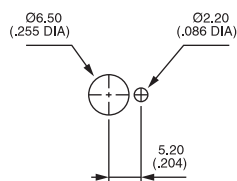

Standard

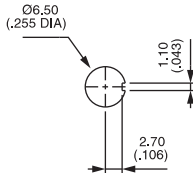

With K
sealing option

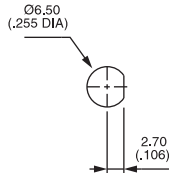

With X408
sealing option

5000 series

Toggle switches - quick-connect terminals



A

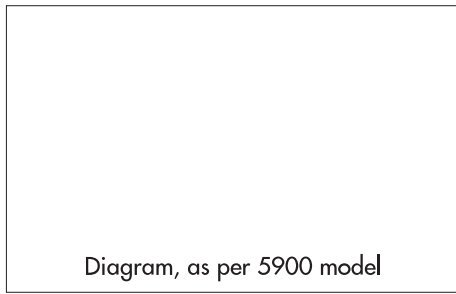

5900Z models

- Flatted bushing $\varnothing 6,35$ mm (1/4)
- Terminal spacing 4,7 mm (.185)
- Epoxy sealed terminals standard
- 1 and 2 pole configurations

MODEL STRUCTURE

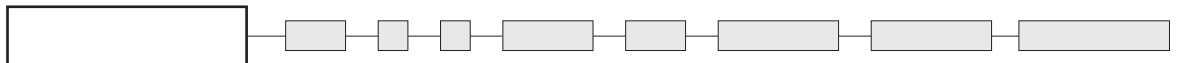

For model structure numbers, refer to 5200Z models and replace 2 with 9.

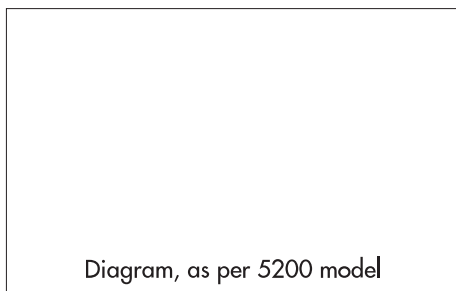
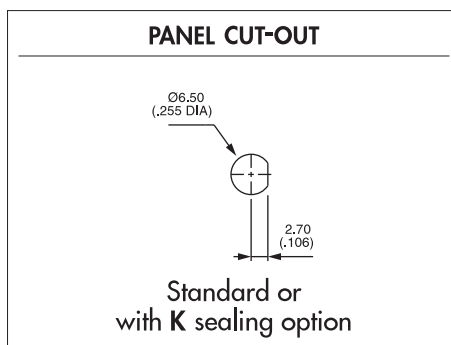

5100Z models

- Threaded bushing $\varnothing 6$ mm x 0.75 SI (.236 x 0.75 IS)
- Terminal spacing 4,7 mm (.185)
- Epoxy sealed terminals standard
- 1 and 2 pole configurations

MODEL STRUCTURE

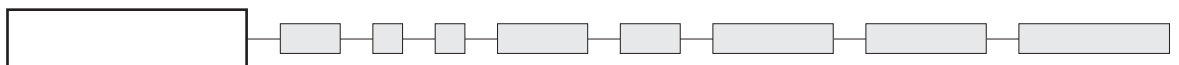

For model structure numbers, refer to 5200Z models and replace 2 with 1.

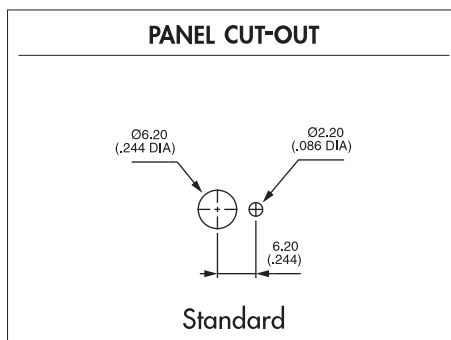



5000 series

Toggle switches - wire-wrap terminals

Threaded bushing $\varnothing 6,35$ (1/4) : 5200MIWR

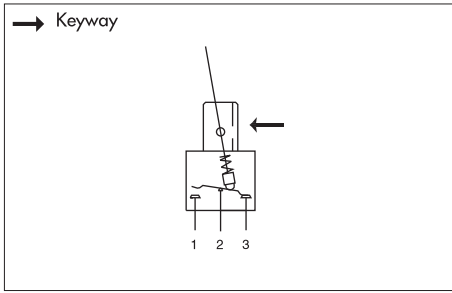

- Terminal spacing 5,08 mm (.200)
- Epoxy sealed terminals standard
- 1 and 2 pole configurations
- Can also be used as extended PCB terminals

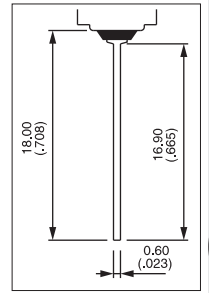

MODEL STRUCTURE

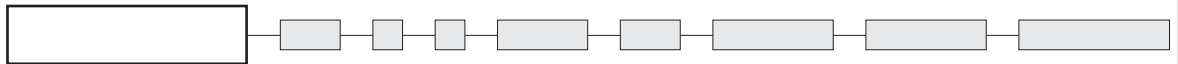

Shown with standard lever

Terminal spacing 5,08 (.200) - single pole



5236MIWR
5239MIWR
5237MIWR
5238MIWR
5232MIWR

III	II	I
2-3		1-2
ON	-	ON
ON	OFF	ON
MOM	OFF	MOM
ON	OFF	MOM
ON	-	MOM

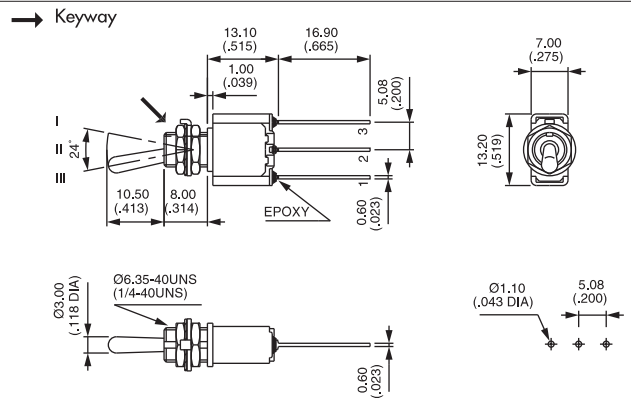

Terminal spacing 5,08 (.200) - double pole



5246MIWR
5249MIWR
5247MIWR
5248MIWR
5242MIWR
5244 1R MIWR*
5244 2R MIWR*

III	II	I
2-3		1-2
5-6		4-5
ON	-	ON
ON	OFF	ON
MOM	OFF	MOM
ON	OFF	MOM
ON	-	MOM
ON	ON	ON
ON	ON	MOM
MOM	ON	MOM

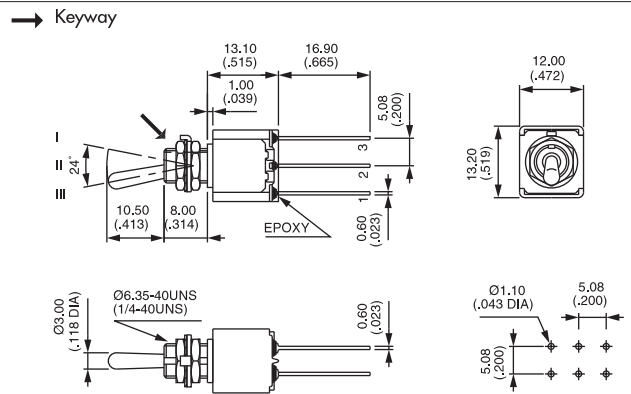

*Function 4 : SP in DP case - specify CT or TH connections, see end of catalogue.

PANEL CUT-OUT

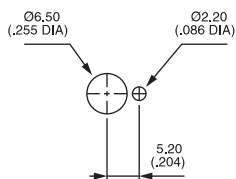

Standard

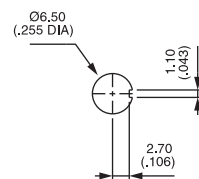

With K sealing option

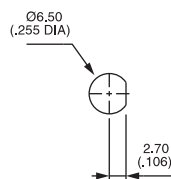

With X408 sealing option

5000 series

Toggle switches - plain bushing

Right angle terminals - horizontal : 5200W



A

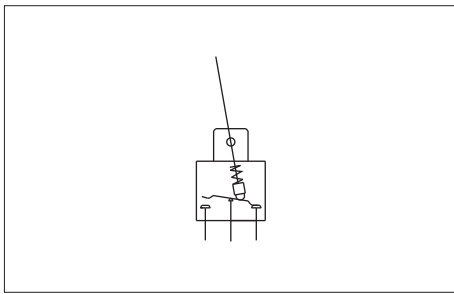

- Terminal spacing 4,7 mm (.185)
- 1, 2 and 3 pole configurations

Special switch **5200WX404** with reduced overall dimensions is presented under "Special options".

MODEL STRUCTURE

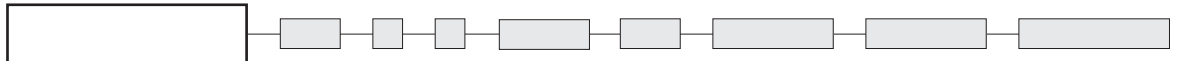

Shown with standard lever

Single pole



5236W
5239W
5237W
5238W
5232W

III	II	I
2-3		1-2
ON	-	ON
ON	OFF	ON
MOM	OFF	MOM
ON	OFF	MOM
ON	-	MOM

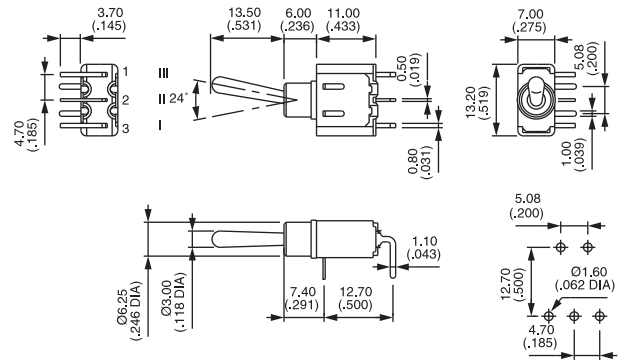

Double pole



5246W
5249W
5247W
5248W
5242W
5244W*
5244W 1R*
5244W 2R*

III	II	I
2-3		1-2
5-6		4-5
ON	-	ON
ON	OFF	ON
MOM	OFF	MOM
ON	OFF	MOM
ON	-	MOM
ON	ON	ON
ON	ON	MOM
MOM	ON	MOM

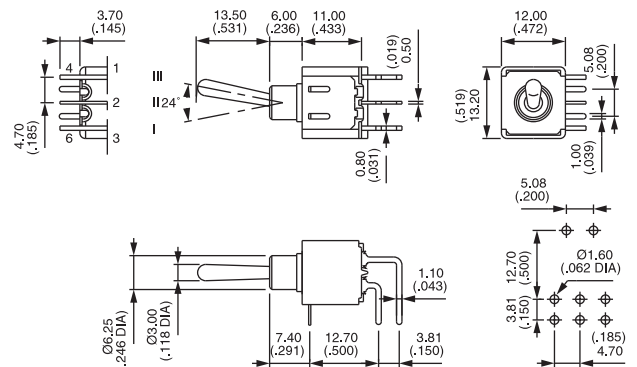

*Function 4 : SP in DP case - specify CT or TH connections, see end of catalogue.

Three pole



5256W
5259W
5257W
5258W
5252W

III	II	I
2-3		1-2
5-6		4-5
8-9		7-8
ON	-	ON
ON	OFF	ON
MOM	OFF	MOM
ON	OFF	MOM
ON	-	MOM

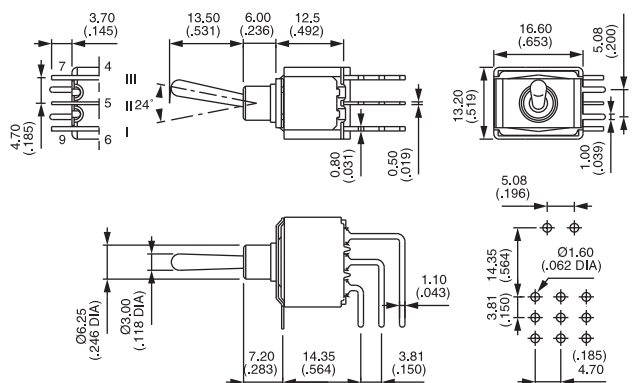



5000 series

Toggle switches - plain bushing

Right angle terminals - horizontal : 5400W

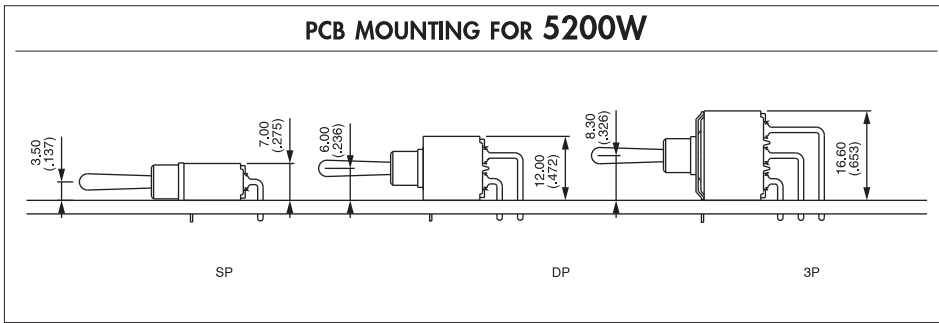

A

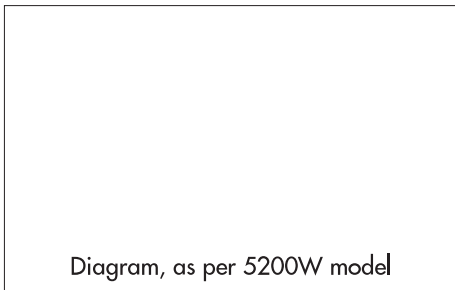

5400W models

- Terminal spacing 4 mm (.157)
- 1 and 2 pole configurations

MODEL STRUCTURE



For model structure numbers, refer to 5200W single and double pole and replace 2 with 4.

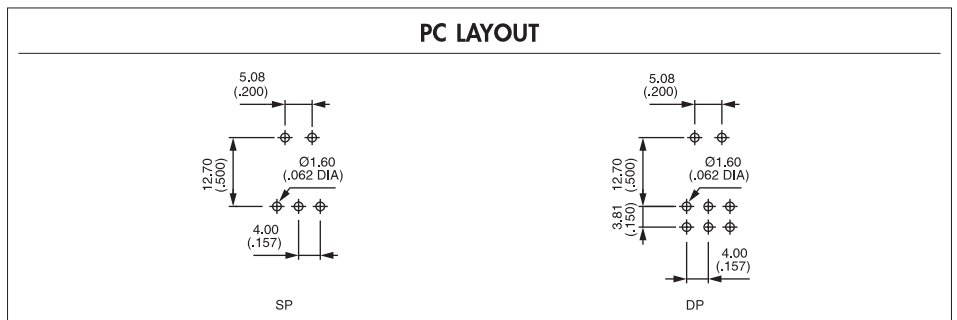

5000 series

Toggle switches - plain bushing

Right angle terminals - vertical : 5200WW

MODEL
STRUCTURE



A

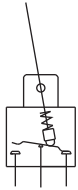

- Pin spacing 3,81 mm (.150)
- 1, 2, 3 and 4 pole configurations

MODEL
STRUCTURE

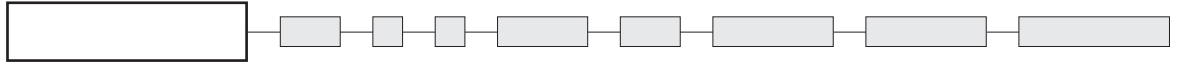

Shown with standard lever

Single pole



5236WW
5239WW
5237WW
5238WW**
5232WW**

III	II	I
2-3		1-2
ON	-	ON
ON	OFF	ON
MOM	OFF	MOM
ON	OFF	MOM
ON	-	MOM

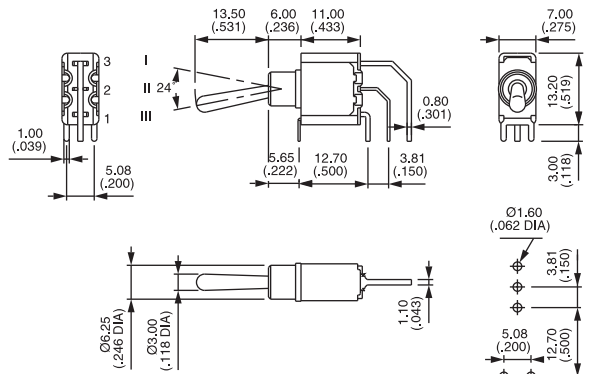

Double pole



5246WW
5249WW
5247WW
5248WW**
5242WW**
5244WW*
5244WW 1R*
5244WW 2R*

III	II	I
2-3		1-2
5-6		4-5
ON	-	ON
ON	OFF	ON
MOM	OFF	MOM
ON	OFF	MOM
ON	-	MOM
ON	ON	ON
ON	ON	MOM
MOM	ON	MOM

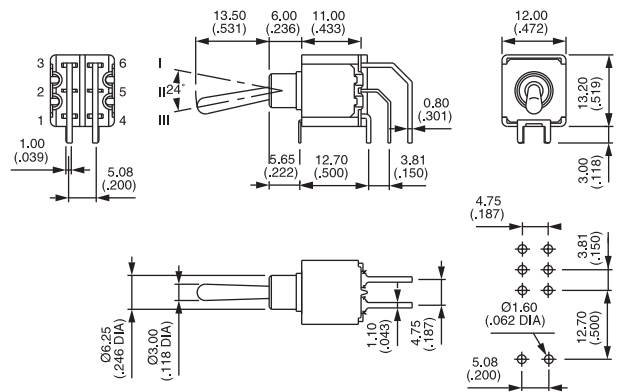

Three pole



5256WW
5259WW
5257WW
5258WW**
5252WW**

III	II	I
2-3		1-2
5-6		4-5
8-9		7-8
ON	-	ON
ON	OFF	ON
MOM	OFF	MOM
ON	OFF	MOM
ON	-	MOM

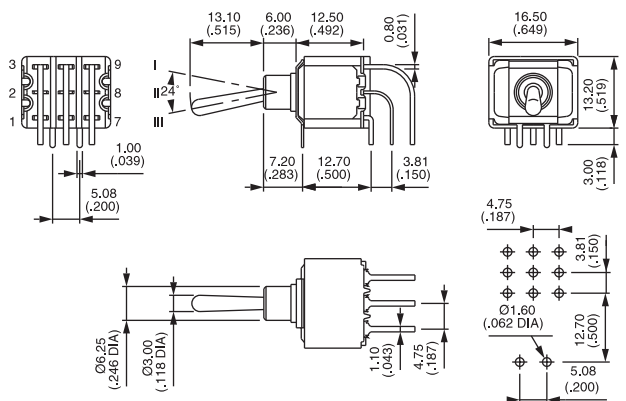

* and ** : see notes next page.



5000 series

Toggle switches - plain bushing

Right angle terminals - vertical : 5200WW - 5400WW

Four pole



5266WW
5269WW
5267WW
5268WW**
5262WW**
5264WW*
5264WW 1R*
5264WW 2R*

III	II	I
2-3		1-2
5-6		4-5
8-9		7-8
11-12		10-11
	ON	- ON
	ON	OFF ON
	MOM	OFF MOM
	ON	OFF MOM
	ON	- MOM
	ON	ON ON
	ON	ON MOM
	MOM	ON MOM

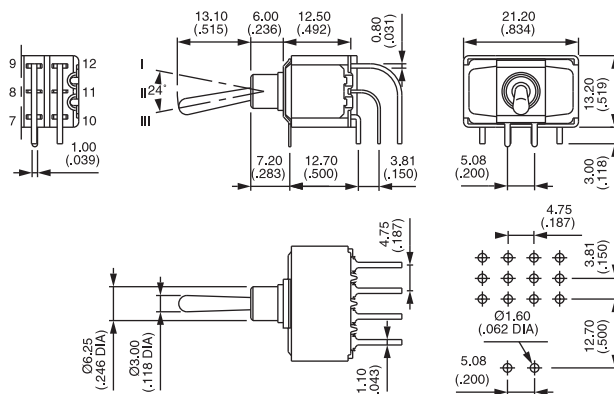

* Function 4 : SP in DP case, DP in 4P case - specify CT or TH connections, see end of catalogue.

** Functions 2 and 8 : reversed connection available, consult factory.

PCB MOUNTING

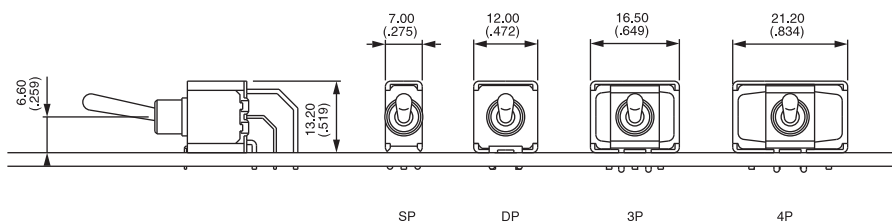

5400WW models

- Pin spacing 2,54 mm (.100)
- 1, 2, 3 and 4 pole configurations

Diagram as per 5200WW model

MODEL STRUCTURE

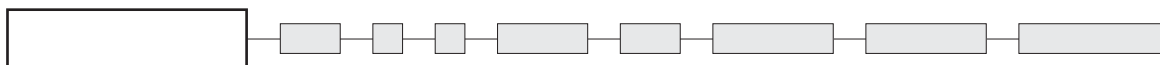

For model structure numbers, refer to 5200WW models and replace 2 with 4.

PC LAYOUT

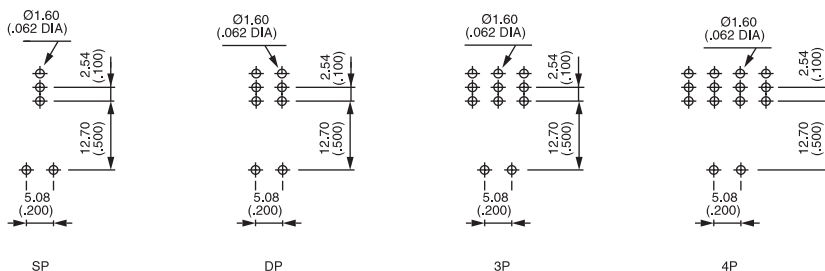

5000 series

Toggle switches - plain bushing

Straight PC terminals - bracket mounting : 5200Y

MODEL
STRUCTURE

A

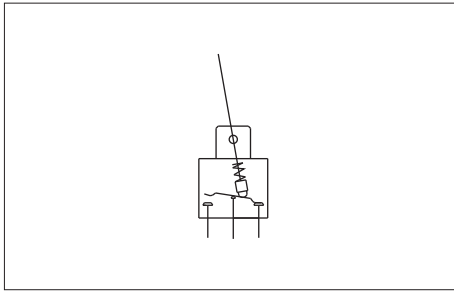

Brackets reduce mechanical stress on solder joints and increase resistance to vibrations.
Bracket material : tin plated steel.

- Epoxy sealed terminals standard
- 1 and 2 pole configurations

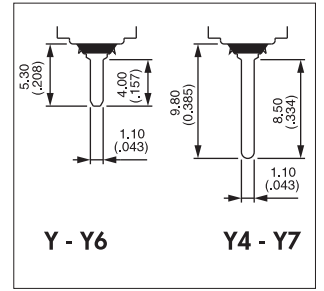

MODEL
STRUCTURE

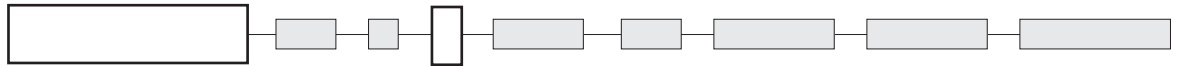

Shown with standard lever

Short bracket - width 15,75 (.620) - single pole : 5230Y



5236Y B
5239Y B
5237Y B
5238Y B
5232Y B

III	II	I
2-3		1-2

ON	-	ON
ON	OFF	ON
MOM	OFF	MOM
ON	OFF	MOM
ON	-	MOM

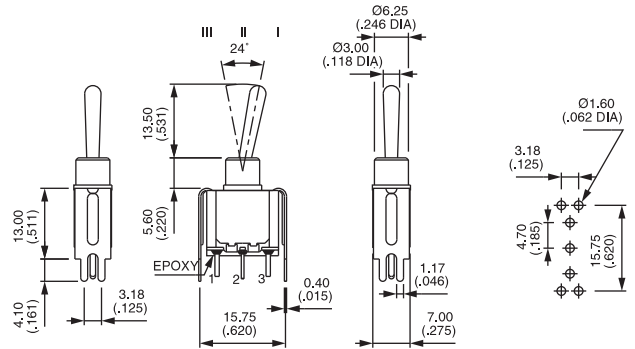

Short bracket - width 15,75 (.620) - double pole : 5240Y



5246Y B
5249Y B
5247Y B
5248Y B
5242Y B
5244Y B*
5244Y 1R B*
5244Y 2R B*

III	II	I
2-3		1-2
5-6		4-5

ON	-	ON
ON	OFF	ON
MOM	OFF	MOM
ON	OFF	MOM
ON	-	MOM
ON	ON	ON
ON	ON	MOM
MOM	ON	MOM

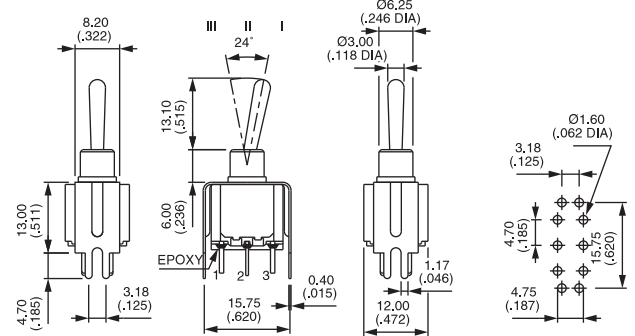

* Function 4 : SP in DP case - specify CT or TH connections, see end of catalogue.



5000 series

Toggle switches - plain bushing

Straight PC terminals - bracket mounting : 5200Y4 - Y6 - Y7

Tall bracket - width 15,75 (.620) : 5200Y4



	Single pole	Double pole	III	II	I
5236Y4 B	5246Y4 B	ON	-	ON	
5239Y4 B	5249Y4 B	ON	OFF	ON	
5237Y4 B	5247Y4 B	MOM	OFF	MOM	
5238Y4 B	5248Y4 B	ON	OFF	MOM	
5232Y4 B	5242Y4 B	ON	-	MOM	
	5244Y4 B*	ON	ON	ON	
	5244Y4 1R B*	ON	ON	MOM	
	5244Y4 2R B*	MOM	ON	MOM	

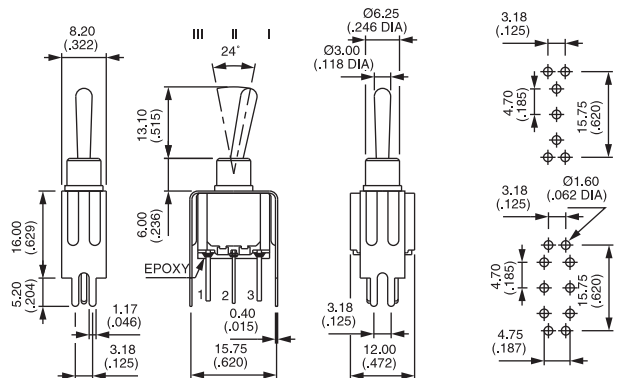

Short bracket - width 19,05 (.750) : 5200Y6



	Single pole	Double pole	III	II	I
5236Y6 B	5246Y6 B	ON	-	ON	
5239Y6 B	5249Y6 B	ON	OFF	ON	
5237Y6 B	5247Y6 B	MOM	OFF	MOM	
5238Y6 B	5248Y6 B	ON	OFF	MOM	
5232Y6 B	5242Y6 B	ON	-	MOM	
	5244Y6 B*	ON	ON	ON	
	5244Y6 1R B*	ON	ON	MOM	
	5244Y6 2R B*	MOM	ON	MOM	

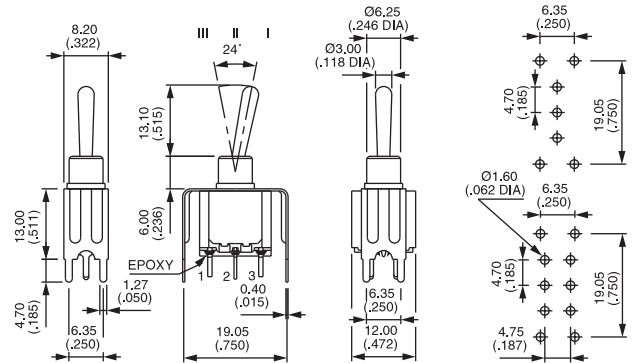

Tall bracket - width 19,05 (.750) : 5200Y7



	Single pole	Double pole	III	II	I
5236Y7 B	5246Y7 B	ON	-	ON	
5239Y7 B	5249Y7 B	ON	OFF	ON	
5237Y7 B	5247Y7 B	MOM	OFF	MOM	
5238Y7 B	5248Y7 B	ON	OFF	MOM	
5232Y7 B	5242Y7 B	ON	-	MOM	
	5244Y7 B*	ON	ON	ON	
	5244Y7 1R B*	ON	ON	MOM	
	5244Y7 2R B*	MOM	ON	MOM	

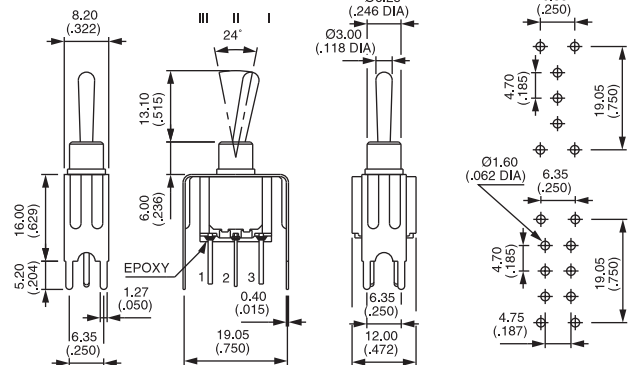

* Function 4 : SP in DP case - specify CT or TH connections, see end of catalogue.

5000 series

Toggle switches

OPTIONS



CONTACT MATERIALS

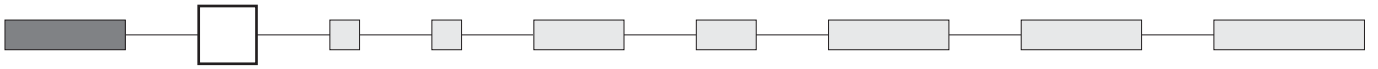

- A Silver
- AD Silver, gold plated
- CD Brass, gold plated

Special contacts for peak currents : see X814, under "Special Options".

FINISH

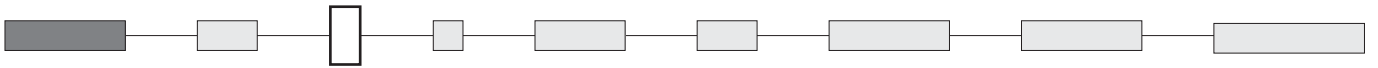

- Blank Bright chrome finish
- G Matt black finish on bushing, actuator and hardware

SEALING

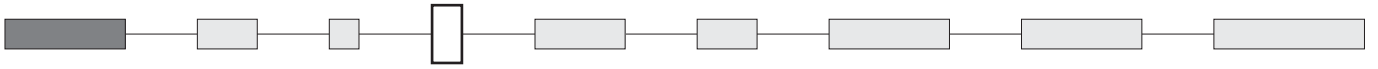

- Blank
 - For 5000 - 5200Z and 5200MIWR models : epoxy sealed terminals standard
 - Other models : no sealing required

- B Epoxy sealed terminals

- K Front panel sealing by one O-ring and sealing washer. Protects the switch against water and dust. Panel seal withstands 1 bar pressure and remains sealed even when switch is operated.



Available on models with $\varnothing 6,35 (1/4)$ or $11,9 (15/32)$ threaded bushing only.
Not available with levers 8, 9, 12, 22, 23.

- KB Combined sealings

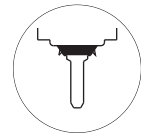

- ① O-ring
- ② Sealing washer

K with $\varnothing 6,35 (1/4)$ keyway bushing



Includes washer
U360

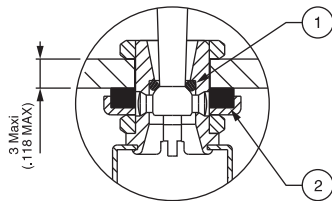

K with $\varnothing 6,35 (1/4)$ flatted bushing



Includes washer
U5141

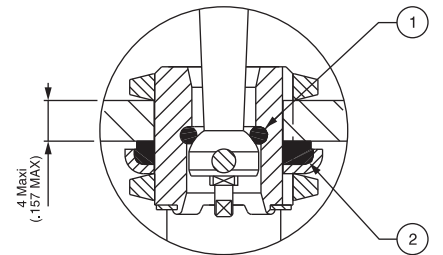

K with $\varnothing 11,9 (15/32)$ keyway bushing

4 Maxi
(~157 MAX)

Includes washer
U60

Sealing by two O-rings, see X408 under "Special options".



5000 series

Toggle switches

FLUORESCENT TIP

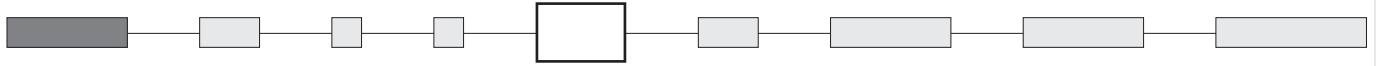

Blank None

Standard lever

Locking lever

038 White fluorescent tip.
Becomes luminous when submitted to ultraviolet rays.



Available with matt black finish (option G) only.

Consult factory for levers available with this option.

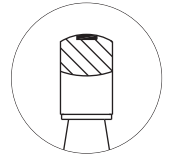
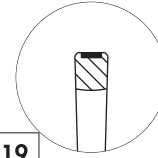

-19

Same dimensions as standard actuator below.

ACTUATORS



Levers for threaded bushing models $\varnothing 6,35$ (1/4) or $\varnothing 6$ (.236)

Dash compulsory before lever code.

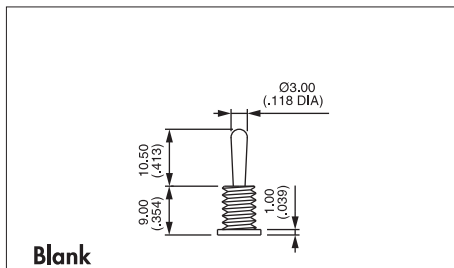

Blank

Standard

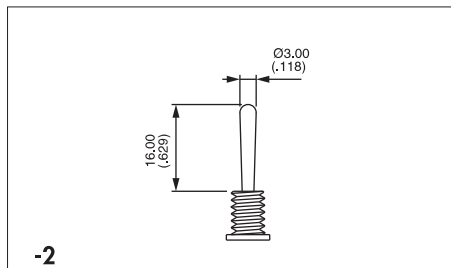

-2

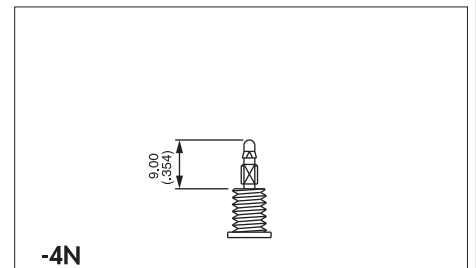

-4N

For use with paddles only

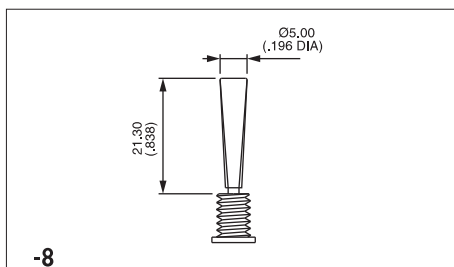

-8

Not available with sealing options K or X408

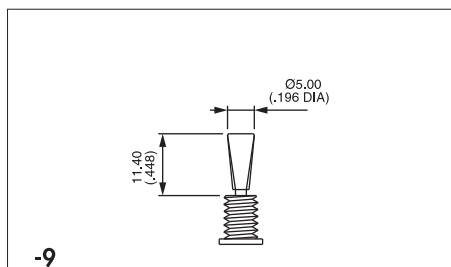

-9

Not available with sealing options K or X408

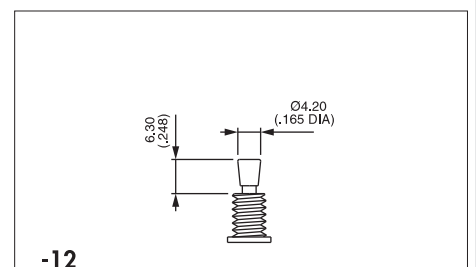

-12

Not available with sealing options K or X408

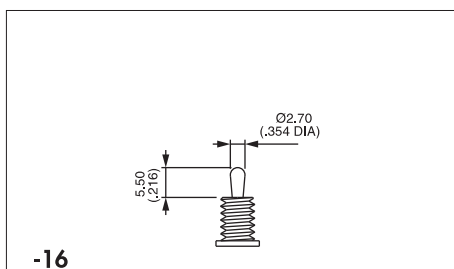

-16

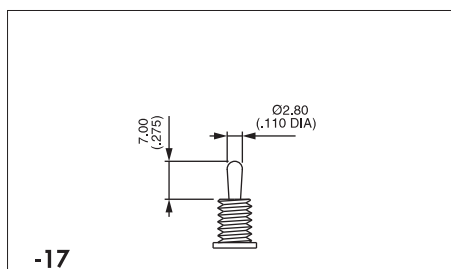

-17

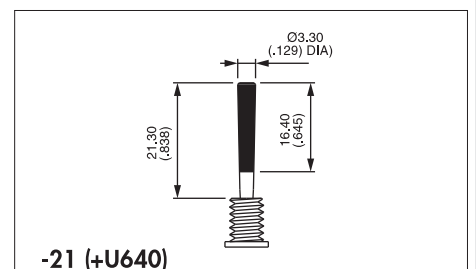

-21 (+U640)

U640 to be placed in last box of ordering format. Replace 0 by colour code.

5000 series

Toggle switches

OPTIONS



ACTUATORS (continued)

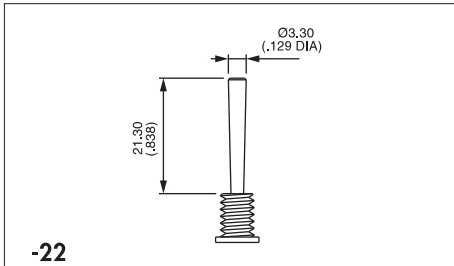

-22

Not available with sealing options K or X408

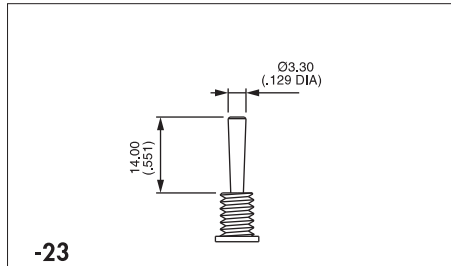

-23

Not available with sealing options K or X408

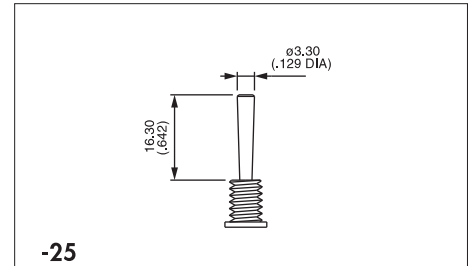

-25

Not available with sealing options K or X408

Levers for threaded bushing models Ø 11,9 (15/32) : 5600M

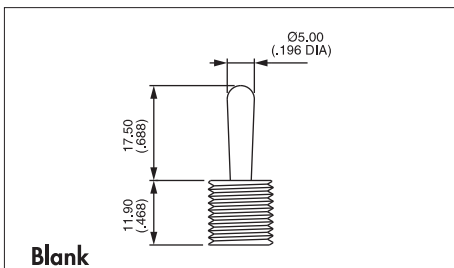

Blank

Standard

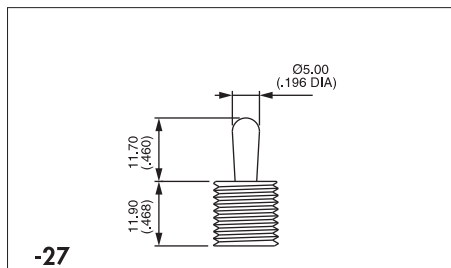

-27

Locking levers

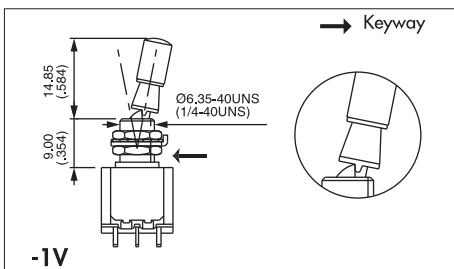

-1V

1 locked position (function 6)

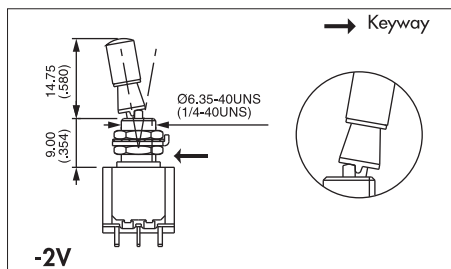

-2V

2 locked positions (function 6)

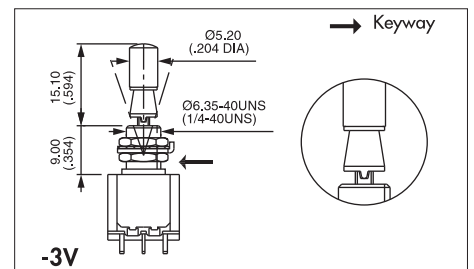

-3V

3 locked positions (functions 9 and 4)

Consult factory for other locking lever options.



Available with Ø 6,35 mm (1/4) threaded bushing models only.
For plain bushing models, see X386 or X916 under "Special options" on the following pages.



5000 series

Toggle switches

ACTUATORS (continued)

For plain bushing models : W - WW and Y

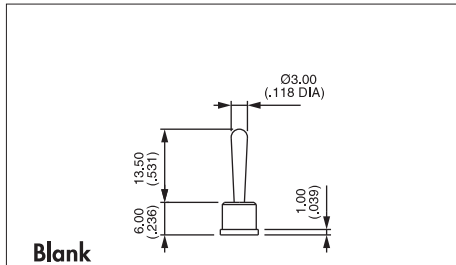

Blank

Standard

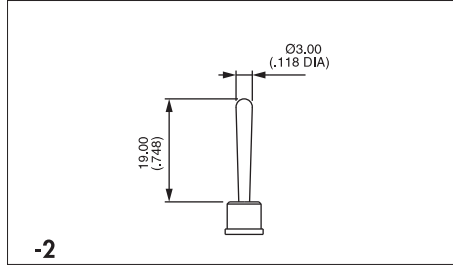

-2

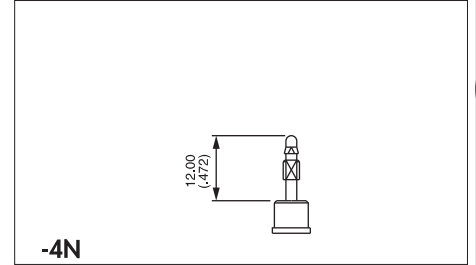

-4N

For use with paddles only

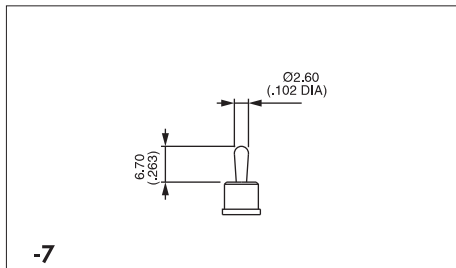

-7

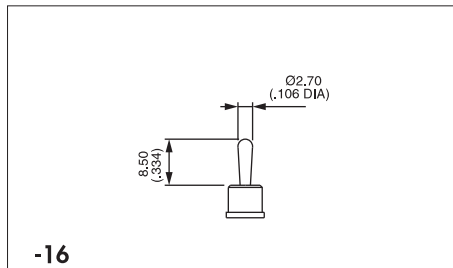

-16

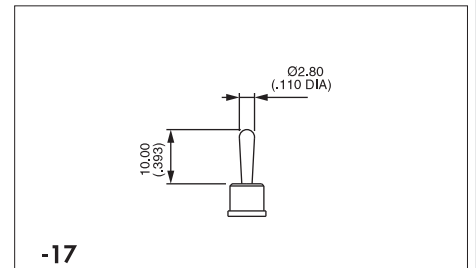

-17

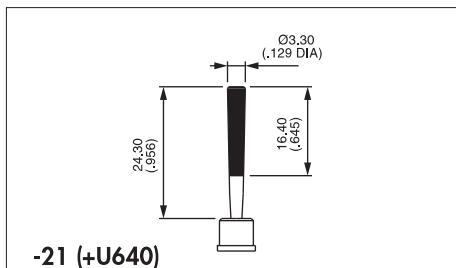

-21 (+U640)

U640 to be placed in last box of ordering format. Replace 0 by colour code.

Actuator colours	
Replace "0" by number	
1	blue
1/4	dark blue
2	black
3	green
4	grey
5	yellow
6	red
7	ivory
7/1	white
9	orange



LEVER LENGTH

With bracket or mounting plate lever length will be reduced by 0,4 mm (.015) as a rule. Please refer to switch technical drawings in "Model Structure" pages for details.

5000 series

Toggle switches

OPTIONS



SPECIAL OPTIONS

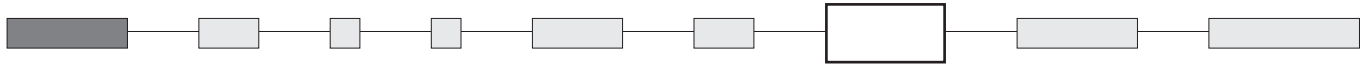

Blank No special requirement

X408 Front panel sealing by two O-rings. Flatted bushing for precise orientation. Protects the switch against water and dust. Panel seal withstands 1 bar pressure and remains sealed even when switch is operated. Includes sealed terminals (option B).



Available only on models with threaded bushing except 5600M. Not available with levers 8, 9, 12, 22, 23.

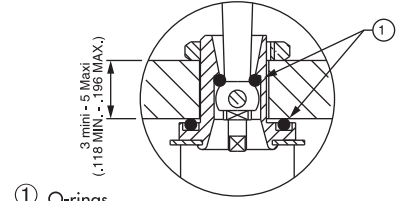

① O-rings

X404 Horizontal right angle with reduced overall dimensions (shown with lever -16)

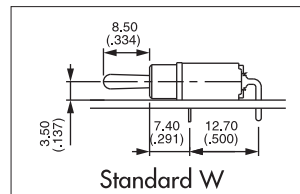

Standard W

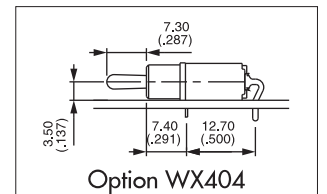

Option WX404



	III	II	I
	2-3		1-2
	5-6		4-5
Single pole			
5236W X404	ON	-	ON
5239W X404	ON	OFF	ON
5237W X404	MOM	OFF	MOM
5238W X404	ON	OFF	MOM
5232W X404	ON	-	MOM
5242W X404	ON	ON	ON
5244W X404*	ON	ON	ON
5244W1R X404*	ON	ON	MOM
5244W2R X404*	MOM	ON	MOM

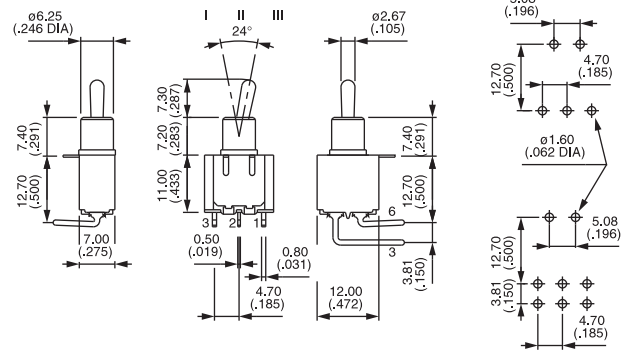

* Function 4 : SP in DP case - specify CT or TH connections, see end of catalogue.

Lever lengths for WX404 (also available with X445 option)

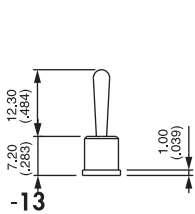

-13

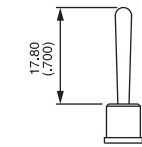

-2

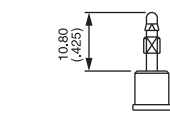

-4N (for paddles)

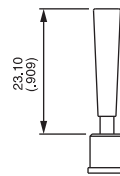

-8

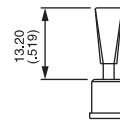

-9

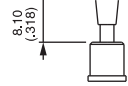

-12

Note : levers -8, -9 and -12 not available with function 2 (ON-MOM)

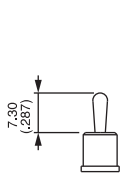

-16

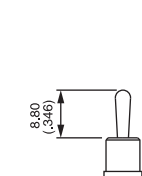

-17

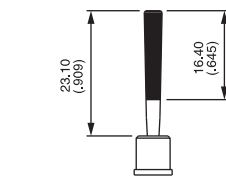

-21 (+U640)*

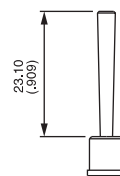

-22

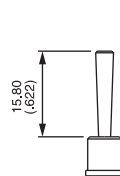

-23

* U640 to be placed in last box of ordering format. Replace 0 by colour code.

Insulating caps and paddles for X404 :

Insulating cap U1710 available with lever style 16.

Paddles U240N, U290N and U390N available with lever style 4N. See details on next pages.



5000 series

Toggle switches

SPECIAL OPTIONS (continued)



With options X372, X386, X442 and X445, the lever lengths indicated on previous pages will be modified.

- X371** Plain bushing \varnothing 6,25 mm (.246) (instead of standard threaded bushing).
- X372** Threaded bushing \varnothing 6,35 (1/4). **Height 7 mm (.274)**.
- X386** Threaded bushing \varnothing 6,35 mm (1/4) to replace plain bushing on models W - WW and Y.
- X442** Threaded bushing \varnothing 6,35 mm (1/4) - **Height 9,9 mm (.389)**.
- X445** Plain bushing. **Height 7,2 mm (.283)** - for W, WW and Y models. Available with the same levers, insulating cap and paddles as X404.
- X601** **Silver plated brass contacts.**
Current/voltage rating for an electrical life of 20.000 cycles :
0,2A 250VAC - 0,4A 125VAC - 0,5A 30VDC.
Minimum quantity : 5.000 pieces per model and shipment.
- X681** **Satin chrome** actuator
- X814** **Switches for peak currents**

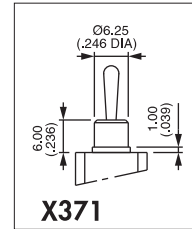

X371

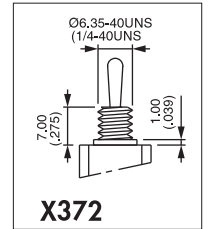

X372

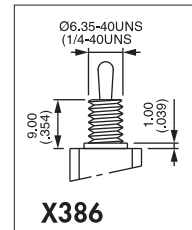

X386

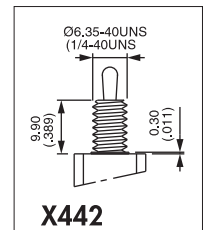

X442

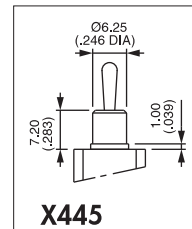

X445

Peak current up to 120A (1 ms) 60VDC - single/double pole



Single pole			
5636A X814	ON	-	ON
Double pole			
5646A X814	ON	-	ON

- Contacts : silver/nickel alloy (AgNi)
- Max. current/voltage rating :
2/120A (1 ms) 60VDC - 10.000 cycles
3/40A 125VAC - 250VAC - 10.000 cycles
- Further specifications and dimensions : see 5600 series.
- General information on peak currents : see end of catalogue.

X902 Plain bushing \varnothing 6,25 mm (.246) - **Height 9 mm (.354)**.

X916 Locking lever on model with plain bushing.

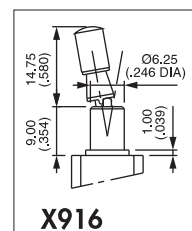

X916

5000 series

Toggle switches

OPTIONS



AGENCY APPROVALS

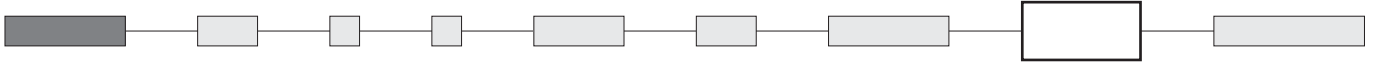

UL
CSA
CECC

All standard models, except 5200MIWR

Standard models 5600 - 5200

Availability : consult factory for details of approved combinations or options.

Marking : to order switches marked UL, CSA or CECC, complete above box with desired approvals, in this order & without space (ex. : ULCSACECC). Blank : no agency approval required.

VDE (with UL & CSA)

Refer to 55000 series on the following pages.

Preferential lists : see specifications.

INSULATING CAPS AND PADDLES

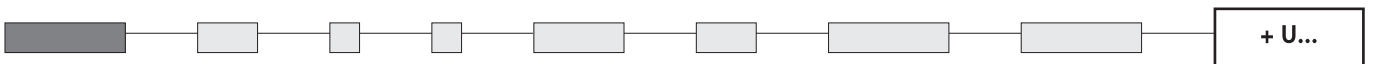

Insulating caps

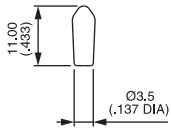

U270

For lever 13 and threaded bushing only

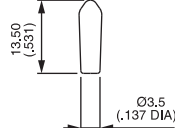

U1040

For lever 13 and plain bushing only

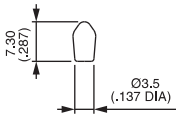

U1710

For lever 17 and threaded bushing
For lever 7 and plain bushing

Cap colours

Replace last
"0" by number

1	blue
1/4	dark blue
2	black
3	green
4	grey
5	yellow
6	red
7/1	white
9	orange



Insulating caps are not available in ivory colour.



5000 series

Toggle switches

INSULATED CAPS AND PADDLES (continued)

Paddles

For use with lever 4N only. Shown with standard threaded bushing. Order separately.

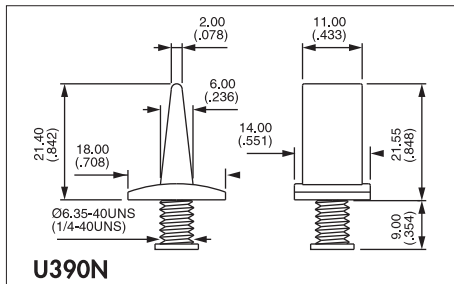
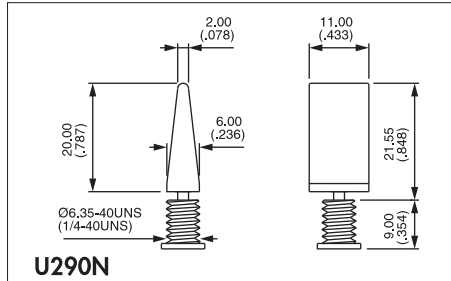
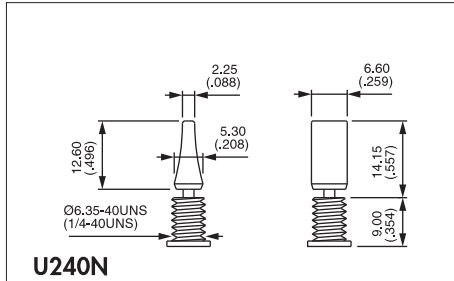

Paddle colours	
Replace last "0" by number	
1	blue
1/4	dark blue
2	black
3	green
4	grey
5	yellow
6	red
7	ivory
7/1	white
9	orange

A